



**ACOUSTIC  
CALIBRATOR  
mod. HD 9101/9102 rev.1**

## Index

1. Application fields
2. Supplying kit
3. Technical data
4. Construction and working principles
  - 4.1 Mechanical construction
  - 4.2 Electronic controlling system
  - 4.3 Working principles
5. Operating instructions
  - 5.1 Putting on duty and measurement
  - 5.2 Corrections due to the microphone's mechanical characteristics
  - 5.3 Calibration of sound level meter and measuring stations
6. Maintenance and repairs
7. Shipping and storage

## Explanation of fig. 1

1. HD 9101 sound level generator
2. 1/2 inch microphone adaptor
3. Button  on-off
4. Button  94 dB/114 dB sound level selector
5. RED LIGHT that indicates the selected sound level
6. RED LIGHT that indicates the selected frequency

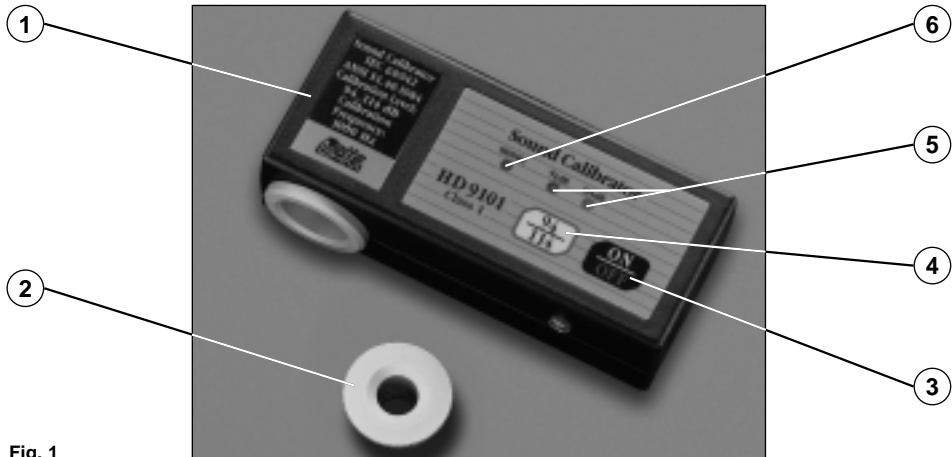

Fig. 1

## 1. APPLICATION FIELD

The HD 9101/02 sound level generator is a battery operated portable sound source, suitable for the calibration of sound level meters (portable and laboratory ones) and acoustic measuring stations. It allows a direct calibration of microphones with diameter equal to 1" and, with a specific adaptor (model 9101040) also 1/2" microphones, with mechanical dimensions suit to the specifications of the IEC 61094-1 ("Measuring microphones. Part 1: Specifications for laboratory standard microphones") and IEC 61094-4 ("Measuring microphones. Part 4: Specifications for working standard microphones") standards.

The benefits of the HD 9101/02 calibrator are:

- With the sound signal frequency at 1000 Hz you can carry out calibrations of sound level meters with any frequency weighting (LIN, A, B, ...), without introducing correction factors.

- The generated sound pressure level is independent from the atmospheric pressure: so it is not necessary to correct the value with of the atmospheric pressure.
- The HD 9101/02 calibrator can be conveniently used in laboratory and on-site.
- Its easiness allows the use by non-qualified personnel.

## 2. SUPPLYING KIT

Sound level generator type HD 9101/02

Accessories:

- Adaptor for 1/2" microphones model 9101040
- IEC 6LF22 alkaline 9V battery
- Instruction manual

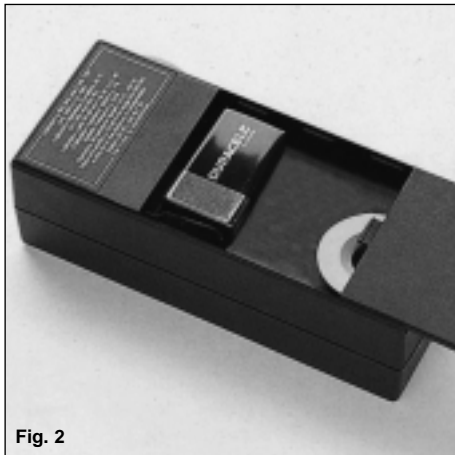

Fig. 2

### 3. TECHNICAL DATA

The HD 9101 calibrator satisfies the requirements of **class 1 according to standard IEC 60942-1988 and the requirements of the ANSI SI.40-1984 standard.** The HD 9102 calibrator satisfies the requirements of **class 2 according to standard IEC 942-1988 and the requirements of the ANSI SI.40-1984 standard.**

Diameter of the microphones that can be calibrated:  
23.77  $\pm$ 0.05 mm 1"  
12.7  $\pm$ 0.03 mm 1/2" (with 1/2" adaptor mod. 9101040)  
standard dimensions according to IEC 61094-1 and IEC 61094-4

Stabilisation time: 60 sec

HD 9101 Frequency: 1000 Hz  $\pm$ 2%

HD 9102 Frequency: 1000 Hz  $\pm$ 4%

HD 9101 Sound pressure level:

94 dB/114 dB  $\pm$ 0.3 dB

HD 9102 Sound pressure level:  
94 dB/114 dB  $\pm 0.5$  dB  
(referred to 101.3 kPa, 23°C  $\pm 3$ °C and 65% R.H.)

Total distortion:  $<0.5\%$

Influence of static pressure (Ref. 101.3 kPa):  
 $\pm 0.1$  dB between 90 kPa and 108 kPa  
 $\pm 0.3$  dB between 65 kPa and 108 kPa

Influence of temperature (Ref. 23°C):  
 $\pm 0.05$  dB between 5°C and 35°C  
 $\pm 0.2$  dB between -10°C and 50°C

Influence of relative humidity (Ref. 50% R.H.):  
 $\pm 0.1$  dB between 10% R.H. and 90% R.H. without  
condense

Stability (one year with normal use):  $\pm 0.1$  dB

Working temperature: -10  $\div$  +50°C

Stockage temperature: -25  $\div$  +55°C

Relative humidity:  $\leq 90\%$  R.H.

Equivalent volume of the calibration chamber (+23°C):  
10 cm<sup>3</sup>

Power supply: IEC 9V alkaline battery type 6F22

Battery lifetime: about 15 hours with alkaline battery

Container material: NORYL NE110 resin

Dimensions: mm 160x140, H=46 mm

Weight: 400 gr.

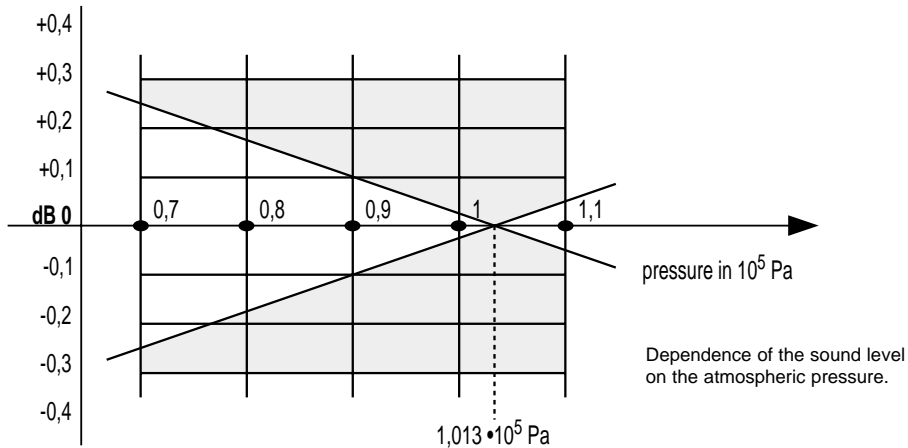

## **4. CONSTRUCTION AND WORKING PRINCIPLES**

### **4.1 Mechanical construction**

In Fig. 3 the structure of the HD 9101 (in section) is schematised. In the bottom part of the container you can find the battery compartment and the housing for the 1/2" microphone adaptor, accessible sliding off the lid. On top of the battery compartment you can find the printed circuit with the electronics, and on the opposite side, the control keyboard. On the left the electro-acoustic transducer system formed by a Helmholtz resonator with piezo-ceramic generator. The system transmits the signal through the 1" microphone seat. A perforated disc in 0.1 mm stainless steel protects the transducer from the danger of mechanical shock, a capillary hole towards the outside balances the static pressure of the chamber protecting the microphones from the overpressure caused by the insertion.

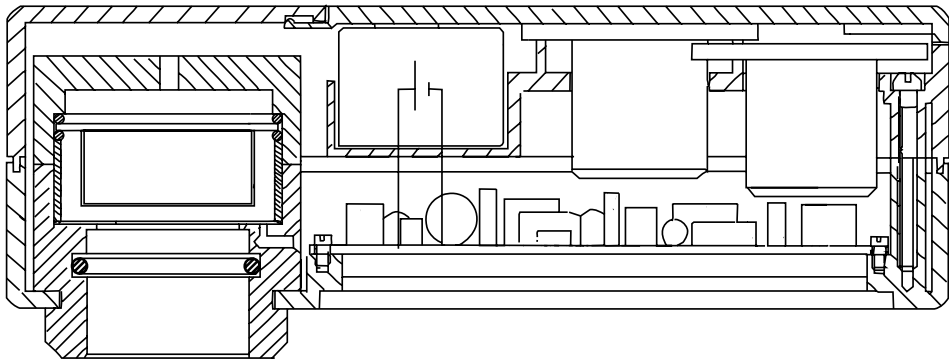

**Fig. 3 Mechanical construction of the calibrator (section).**

## 4.2 Electronic control system

In Fig. 4 we find the block diagram of the calibrator.

The main part of the electronics is an oscillator with high stability and low distortion formed by a dual amplifier with RC reaction net and an RMS converter, the automatic gain control circuit (AGC) and the ceramic resonator driver.

The stabilised reference voltage is compared to the battery voltage determining the charge conditions. If the battery is low on charge, the selected lights blink indicating that you have to replace the battery.

The influence of working temperature on the oscillator, concerning frequency and amplitude, is compensated; the generated sound level presents minimum variations towards temperature.

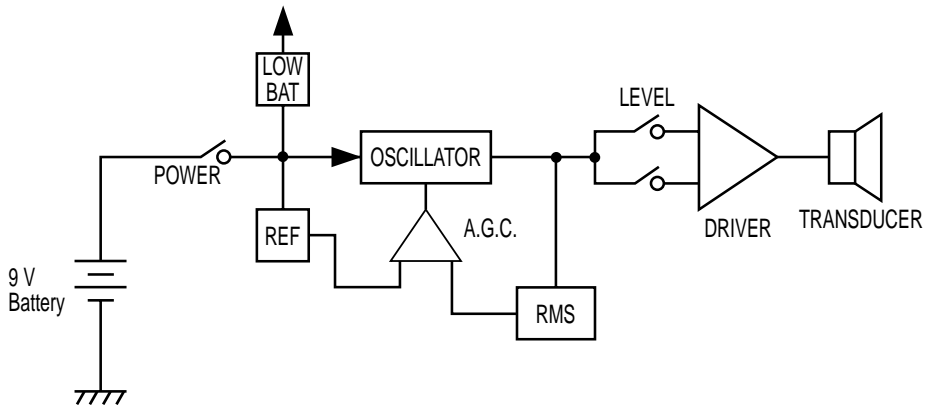

**Fig. 4 Block diagram of the electronic part.**

### 4.3 Working principles

The calibrator's equivalent acoustic circuit is schematised in Fig. 5.

In the generator's equivalent acoustic circuit we find: the piezo-ceramic generator, the Helmholtz resonator, the acoustic impedance of the volume between piezo-ceramic resonator and microphone and, at the end, the coupled microphone's acoustic impedance. The calibrator equivalent electronic circuit has been optimised so that the environmental climatic variations (temperature, atmospheric pressure, relative humidity) weigh in a negligible way on the generated sound pressure level.

The transduction system high quality factor reduces further on the already low distortion factor of the electric excitation lower than 0.5%.

With the HD 9101 calibrator you can also calibrate microphones with wide pass-band, without errors. The current absorption lower than 15mA allows operating the calibrator for a long time, in laboratory or on-site, without auxiliary sources but with a simple battery.

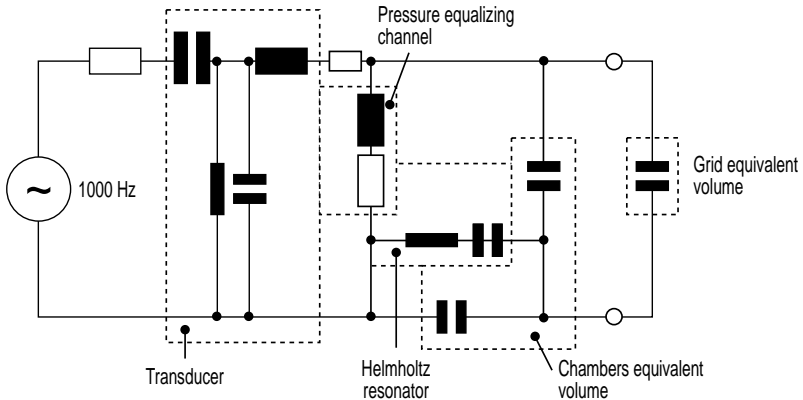

**Fig. 5 Working principle of the calibrator's equivalent acoustic circuit.**

## 5. OPERATING INSTRUCTIONS

### 5.1 Putting on duty and measurement

The calibrator is supplied by an IEC 6F22 9V alkaline battery. To insert the battery slide off the lid on the bottom part of the calibrator, connect the battery to the contacts paying attention to the polarity of the contacts, place the battery into its seat, close the lid. The calibrator's battery voltage is constantly checked during operation and if it goes below 7.5V the lights start flashing and starting from that moment the lifetime of the calibrator is one more hour.

If you don't hear a 1000 Hz tone when you switch it on, check the battery's state of efficiency. If it doesn't depend on this, check the battery's connection header. To carry out the calibration, insert the microphone all the way down the calibrator's cavity, the resistance you encounter is caused by the OR seal, for the 1/2" microphone use the specific adaptor included within the accessories.

During the measurement do not remove the microphone or the calibrator and be sure that the base on which it's placed does not transmit unwanted signals due to eventual vibrations. A small shift between microphone axis and calibrator axis is tolerable.

The button  Switches the calibrator on or off.

The button  Selects the sound intensity, 94 dB or 114 dB.

The illuminated red light during operation indicates for which sound intensity the calibrator is set up.

With the HD 9101 and HD 9102 calibrators you can calibrate any kind of sound level meter of class 1 (only HD 9101), 2 or 3 according to IEC 651 and IEC 804 standards or ANSI S1.4 1983, equipped with laboratory or working standard microphones, with 1" or 1/2" diameter, satisfying the IEC 61094-01 and IEC 61094-4 standards.



## 5.2 Corrections due to the microphone's mechanical characteristics

The HD 9101/HD 9102 calibrator generates a well known sound pressure level calibrated with a standard microphone and so with a given resonator load volume. Different microphones present different equivalent volumes so it may be necessary to carry out corrections to the nominal calibration level in function of the type of microphone used. In the following chart we find the list of corrections that must be carried out to the sound pressure level for some kind of microphone of well known equivalent volume.

In case the microphone in calibration is not included among the listed types, do not hesitate to contact the Delta Ohm Acoustic Laboratory for the determination of the relative  $\Delta L_V$  correction factor.

In case you want to calibrate a sound level meter equipped with a free field response characteristic microphone, it may be necessary to add a small cor-

rection factor due to the difference between the microphone's pressure sensitivity and the effective sound field (free or diffused) sensitivity. The presence of a microphone in free field causes an alteration of the sound field with a consequent increase of the pressure in front of the microphone's membrane. This phenomenon causes a progressive increase with the frequency of the transduction factor in free field compared to the pressure one. With 1/2" microphones with free field response characteristic, the typical free field transduction factor is greater than the pressure one of about 0.15 dB. You can set up for this correction factor calibrating the sound level meter equipped with 1/2" microphone with free field response characteristic at 93.8 dB (corresponding to 0.9980 Pa) instead of 94 dB. In the following table we find the corrections to add to the nominal sound pressure level supplied by the calibrator, for microphones with free field response characteristic.

Dimensions of the microphone	Type of microphone	Corrections to the sound pressure level $\Delta L_v$ [dB]
1"	B&K 4131/32	-0.1
	B&K 4144/45	0.1
	B&K 4179	-0.1
	MG MK102	0.1
1/2"	B&K 4129/30	0.0
	B&K 4133/34	0.0
	B&K 4147	0.0
	B&K 4148	-0.1
	B&K 4149	0.0
	B&K 4155	-0.1
	B&K 4165/66	-0.1
	B&K 4176	0.0
	B&K 4180	0.1
	B&K 4181	0.0
	B&K 4183	0.0
	B&K Falcon™ Range 4188÷4193	0.0
	MG MK221	0.0
	RION UC-52	0.1

**Chart 1: Corrections to the sound pressure level for some kind of microphone with well known equivalent volume.**

MICROPHONE	
1"	1/2"
-0.4 dB	-0.2 dB

**Chart 2: Corrections to the nominal sound pressure level for different types of sound field.**

The corrections listed in Charts 1 and 2 must be opportunely summed in order to keep the type of microphone used and the relative response characteristic in consideration. If, for example, in free field you want to calibrate a sound level meter that uses a microphone type B&K 4155 for free field measurements, you will have to sum the two corrections equal to 0.1 dB (Chart 1: 1/2" B&K 4155) and -0.2 dB (Chart 2: 1/2" Microphone) to the nominal sound pressure level supplied by the calibrator. So you will compare, and eventually correct, the reading of the sound level meter with a value equal to 93.7 dB or 113.7 dB depending on the selected calibration level. Instead, in case you want to calibrate a B&K 4180 type microphone for sound pressure measurements, you will only have to consider the correc-

tion equal to 0.1 dB (Chart 1: 1/2" B&K 4180). So, the calibration level will be equal to 94.1 dB or 114.7 dB depending on the selected calibration level.

### **5.3 Calibration of sound level meters and sound level measuring stations**

Sound level meters or complete measuring stations are calibrated, with any frequency weighting, by adjusting the potentiometer dedicated to instrument calibration until the analog or digital indicator shows the nominal sound pressure of 94 dB or 114 dB. The calibrator's nominal level must be corrected in order to keep the type of microphone in consideration, as explained in step 5.2.

The calibration can be carried out independently with weighting filter on or off. At the frequency of 1000 Hz the attenuation of every filter is equal to 0 dB.

For the calibration proceed as follows:

1. Insert the microphone into the calibrator, the microphone forces to get into the calibrator's cavity because of the OR seal (once in a while it's good to lubricate the OR with silicon grease or oil).
2. Turn on the calibrator with the button **ON**/**OFF** Turn on the sound level meter that must be calibrated.
3. Select the signal level 94 dB or 114 dB.
4. Wait 30" until the signal is stabilised. Carry out the reading, if necessary act on the sound level meter's calibrating device in order to calibrate the indication to the correct level.
5. Once you have carried out the calibration, turn off the calibrator with button **ON**/**OFF** , turn off the calibrated instrument and slide the microphone out of the calibrator.



## 6. MAINTENANCE AND REPAIRS

The calibrator is maintenance free. If you don't hear a 1000 Hz tone after turning it on you must check the battery voltage, which must be at least 8V with a 15mA load. In any other case you must replace the battery (see 5.1). If the defect persists, send the calibrator to the manufacturer or to the nearest assistance centre. After having it repaired, the calibrator must be submitted to calibration in order to guarantee the conformity to norms IEC 942 and CEI EN 60942 standards.

- It is advisable to take off the battery if the calibrator is not used for long periods.
- If the battery is discharged, immediately replace it because in this way the calibrator is always ready and efficient. Don't throw away the battery in the environment but place it in the specific containers.
- Use only good quality sealed alkaline batteries.
- Avoid corrosive liquid leaks from the battery.

## 7. SHIPPING AND STORAGE

The shipping and the storage in the original packing is allowed in a temperature range included between -25°C and +55°C, humidity below 85% and without condense. In the warehouse avoid areas in which:

- The humidity is high.
  - The calibrator is exposed to direct sunlight.
  - The instrument is exposed to a high temperature source.
  - There are strong vibrations.
  - There's vapour, gas and/or corrosive gas.
- 
- The calibrator's case is in NORYL NE110 resin, it doesn't have to be cleaned with detergents that may damage it.

## WARRANTEE CONDITIONS

All our instruments have been submitted to accurate tests and are covered by a 24-month warrantee starting from the date of purchase. The Company will repair or replace for free the parts that will be considered non efficient to its judgement in the warrantee period. This is not valid for the whole replacement of the instruments and neither for refund requests for consequent damage. The repair is carried out at our Assistance Centre. The shipping costs are at the purchaser's expense. Not included in the warrantee: accidental damage caused by shipping, incorrect use or carelessness, connection to a wrong voltage, the sondes, the sensors, the electrodes and all the accessories. Also

the product repaired, tampered with or verified by unauthorised third parties is excluded from the warrantee. The warrantee on the product is operative only if: the coupon has been filled in all of its parts and sent back to the Company within 15 days after the date of purchase; the warrantee certificate that remains to the purchaser must accompany the apparatus sent for the repair. For any controversy, the Padova Court of Justice is competent.

When you ship an instrument for a repair, please photocopy the form you find in the last page of the instruction booklet, fill in the copy with the reason of the return or the anomaly found and the instrument's serial number.

The instrument will be repaired and it will be returned to you as soon as possible.