

# HD 9021

## INSTRUCTIONS MANUAL

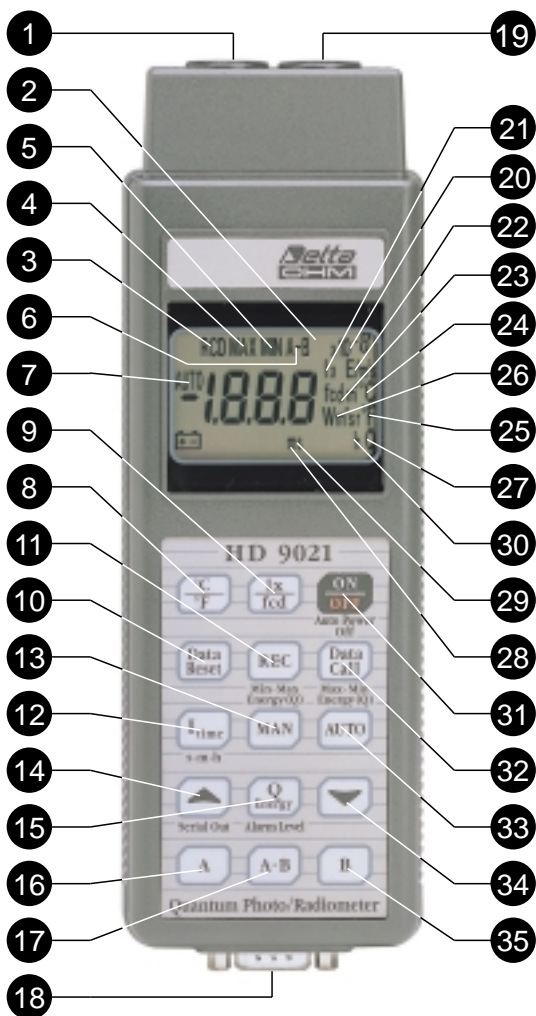

# HD 9021











# HD 9021





ENGLISH





QUANTUM - PHOTO - RADIOMETER

- 1 Input A socket, DIN 8-pole connector
- 2 Display
- 3 REL: the symbol indicates that the instrument is storing the Maximum, Minimum and Q energy values
- 4 MAX: the symbol indicates the maximum value of the chosen unit
- 5 MIN: the symbol indicates the minimum value of the chosen unit
- 6 A, B, A-B: the symbol indicates the relative value at the input A, B, or the difference between the two inputs A-B
- 7 AUTO: the symbol indicates that the automatic change of scale device is enabled
- 8 °C/°F: key for selecting temperature reading in °C or °F
- 9 lx/fcd: key for selecting reading in lx=lux or fcd=footcandle
- 10 Data reset: the key erases the memory of the maximum, minimum and Q energy values and the integration time
- 11 REC: when this key is pressed, the maximum, minimum and Q energy values and the integration time in seconds, minutes, hours, are stored and updated
- 12 ltime: when this key is pressed in sequence, the integration time that has elapsed appears on the display in s=seconds, m=minutes and h=hours
- 13 MAN: key for choosing the working scale manually
- 14 ▲, Serial out: the key has two functions. The first of these, when pressing the Q key, makes the value advance towards the top of the acoustic alarm signal intervention threshold, the second enables the serial output for one item only and, if pressed for more than 3 seconds, enables the serial output continuously with a fixed rate of 10 seconds
- 15 Q energy: when the key is pressed, followed by the ▲ and ▼ keys, this sets the threshold value above which the alarm intervenes
- 16 A: key for activating the display of input A
- 17 A-B: key for activating the display of the difference between inputs A and B
- 18 SUB D male 9-pole connector. The cable with electronics for the serial output RS232C, code AD RS232C, may be coupled to this connector
- 19 Input B socket, DIN 8-pole connector
- 20  $\times 10^{\pm n}$ : multiplication factor for the chosen unit; this may be  $10^3$ ,  $10^6$ ,  $-10^3$ , or  $-10^6$
- 21 lx: symbol indicating that the reading is in lux
- 22  $\mu\text{Einstein}$ : symbol indicating that the reading is in  $\mu\text{Einstein}$
- 23  $\text{fcd}/\text{m}^2$ : symbol indicating that the measurement is in footcandle  $\text{m}^2$
- 24 °C: symbol indicating that the temperature measurement is in °C
- 25 °F: symbol indicating that the temperature measurement is in °F
- 26  $\text{Wm}^2$ : symbol indicating that the measurement is in  $\text{Wm}^2$
- 27 Q energy: symbol indicating the quantity of energy in the integration time X
- 28 m: integration time in minutes
- 29 s: integration time in seconds
- 30 h: integration time in hours
- 31 ON/OFF: key for switching the instrument on or off
- 32 DATA CALL: key for calling and reading on the display the stored maximum, minimum and Q values
- 33 AUTO: this key enables the automatic change of scale function of the instrument
- 34 ▼, after the Q energy key has been pressed, this key reduces the threshold value above which the acoustic alarm intervenes
- 35 B: key for activating the display of input B.

Key	Symbols lit besides the numbers	Description
	All the symbols are lit for a few seconds after switching on.	Key for switching the instrument on and off. The instrument switches off automatically about 8 minutes after this key has been pressed, as it has a built-in switch-off device. If any key other than the ON/OFF key is pressed, the instrument switches off 8 minutes after the last key was pressed.
	lx/fcd	For measuring ILLUMINANCE; when this key is pressed the reading may be in the photometric unit lux or foot candle if a photometric probe is fitted in the instrument.
	°C/°F	If a temperature probe of the TP870 series is fitted in the instrument, this indicates the temperature measured by the probe. The key may be pressed alternately to give a reading in °C or °F.
		When the key is pressed it erases from the memory and resets the maximum, minimum and integrated Q energy values, then resets the count of the time elapsed.
	RCD 	When the key is pressed the instrument stores and updates the maximum, minimum and integrated Q energy values for the time elapsed, recorded by the measurement probe fitted. The battery symbol fla-

Key	Symbols lit besides the numbers	Description
	MAX MIN	<p>shes.</p> <p>During the RCD phase the AUTO-POWER-OFF function is disabled, that is the instrument does not switch off automatically. To switch off, press the ON/OFF key. If the stored data are not reset they remain in the memory until REC is pressed again. When the key is pressed for the first time it starts storing data in the memory, the second time it stops data storage (the data stored so far are not erased), the third time it restarts storage and updates the data.</p>
	AUTO	<p>When the key is pressed during RECORD phase or at the end of Q RECORD, before the DATA RESET key is pressed, the display shows in sequence the maximum value recorded by the probe, the minimum value, the Q Energy value and finally the current value. If the DATA RESET key has been pressed, the "Err" message appears on the display, referring to the maximum, minimum and Q Energy values.</p> <p>When the AUTO key is pressed the instrument chooses what scale to operate on. Change of scale is automatic.</p>

Key	Symbols lit besides the numbers	Description
		When the MAN key is pressed the user chooses what scale to operate on. There are 4 scales available, except for temperature measurement where there are 2.
	s m h	When this key is pressed the Q Energy integration time that has elapsed since the REC key was pressed appears on the display in seconds, minutes or hours. To quit the routine, press the key for the channel in which the reading is being taken.
	MAX - Q	When this key is pressed followed by the $\Delta$ and $\nabla$ keys, it sets the maximum value of the Q Energy threshold above which a buzzer sounds to indicate that the set threshold has been reached. When pressed for the second time it indicates the set threshold. The value goes from 0 to 1999, then continues with $10^3$ and $10^6$ . Q Energy calculation begins when the REC key is pressed and continues until it is interrupted by pressing REC again. When the set threshold is exceeded the internal buzzer sounds intermittently as long as the instrument is in record mode. <b>NOTE:</b> When setting the alarm threshold, if the keys  and $\Delta$ (or $\nabla$ ) are pressed simultaneously, this makes the value on the display advance faster. This may be useful

Key	Symbols lit besides the numbers	Description
		if a high value is to be set.  This key has two functions; in the first, when Q is set, it increases the value; the second function enables the serial output. When the key is pressed only once, the figure shown on the display is sent to the serial output. If the key is pressed for more than three seconds the continuous serial output is enabled; this means that what is shown on the display is sent continuously to the serial output every 10 seconds. To quit, press the $\Delta$ key. During Q setting the serial output is disabled.
		During setting of the maximum Q threshold this key is used to decrease the set value.
	A	Key for selecting the input A probe, if the probe is not inserted the "Err" message appears.
	B	Key for selecting the input B probe, if the probe is not inserted the "Err" message appears.
	A-B	Key for displaying the difference in value between inputs A and B; if no probe is inserted, or if the probes are of a different type, the message <b>E1</b> appears.

Key	Symbols lit besides the numbers	Description
	<b>Err</b>	If the probe is not connected to the instrument when it is switched on, or if there is a break in the probe, the " <b>Err</b> " message appears.
	<b>E1</b>	This message appears on the display when the user tries to obtain the difference between inputs A and B when two probes of different types are connected.
	<b>OFL</b>	This symbol appears on the display when the reading is out of scale.

## PROBE CONNECTION

The HD 9021 may be fitted with either one or two probes; the instrument has two DIN 45326 8-pole inputs, input A and input B. If only one input is used, be careful when using the keys for input A or B.

The instrument recognizes the type of probe connected, which is distinguished by a suitable code; it then gets ready to take the measurement according to the characteristics of the probe connected. The connectors are polarized and it takes a certain effort to insert or remove them; proceed in such a way as to avoid damaging the connector, do not pull the cables to disconnect the probe as there would be a risk of tearing them.

## HOW TO MEASURE

Press the ON/OFF key to switch on the instrument. If the probes are connected, the instrument is ready to indicate their value. The instrument may be fitted with probes for measuring temperature ( $^{\circ}\text{C}$ ,  $^{\circ}\text{F}$ ), probes for **photometric** measurements (lux, fcd) or **radiometric** probes ( $\text{W}/\text{m}^2$ ). When the instrument is switched on the auto-power off device is activated; this means that the instrument switches off automatically after 8 minutes unless another key is pressed. If the instrument switches off automatically while a measurement is being taken it is sufficient to switch it back on.

Measurements are taken by positioning the probe in the desired point; the choice of the type of probe, the position and place depend on the type of recording that the user intends to make.

The operator must be sure that his own presence, foreign bodies or outside sources do not interfere with the recording.

The light emitted by a lamp varies with the square of the current, so there may very well be variations in values during the test which the human eye does not detect.

When measuring temperature choose the probe most suited for the case: immersion, penetration or surface probes. It is sufficient to immerse the probe in the liquid of which you want to measure the temperature or place in contact with the surface; in the case of penetration probes, the tip of the probe must penetrate the block in which the temperature is to be measured.

## **METHOD OF USE**

Although the probes are sturdy, they must be used with due care so as to avoid spoiling, scoring or breaking the filters or diffusors. Do not use them at temperatures higher than 50°C; be careful when there is a concentration of luminous beams or arc lights.

- Do not use the probes in the presence of corrosive gases or liquids or immerse them in liquids unless they are made for these purposes.
- Always use the most suitable probe for the measurement to be taken.
- Be careful with the range of use of the probe.
- Always clean the probes carefully after use.
- The instrument is resistant to water but it is not watertight, so if it should fall into the water, take it out immediately and check that no water has infiltrated.

## LOW BATTERY WARNING

If the battery voltage falls below acceptable levels, a beep sounds every 30 seconds and the  symbol appears. From that moment there remains about 1 hour autonomous operation, however the battery should be replaced as soon as possible.



To change the battery turn the screw on the door of the battery compartment in an anti-clockwise direction.

After replacing it (with an ordinary 9V battery IEC 6LF22) close the door, inserting the tag on the door into the slot provided, and turn the screw in a clockwise direction.



**Ensure that the instrument is switched off before changing the battery.**

## FAULTY OPERATION WHEN SWITCHING ON AFTER CHANGING THE BATTERY

If the instrument does not switch on or off after changing the battery, repeat the battery changing procedure, waiting for a few minutes after removing the battery to allow the circuit condenser capacities to be completely discharged, then insert the battery.

Check that the battery you are using is really efficient; sometimes unused batteries have not been recently manufactured so, due to the auto-discharge phenomenon, their voltage level is insufficient for correct operation of the instrument.

## WARNING

- \* If the instrument is not to be used for a long period the battery should be removed.
- \* If the battery is flat it must be replaced immediately.
- \* Avoid leakage of fluid from the battery.
- \* Always use good quality watertight batteries.

## MAINTENANCE

Storage conditions.

\* Temperature: -20 to +60°C

\* Humidity: less than 85% relative humidity.

\* Do not store the instrument in places where:

1 - There is a high degree of humidity.

2 - The instrument is exposed to direct sunlight.

3 - The instrument is exposed to a source of high temperature.

4 - There are strong vibrations.

5 - There is steam, salt and/or corrosive gas.

The instrument body is made of plastic so it must not be cleaned with solvents which can spoil plastic.

## SERIAL OUTPUT

To enable the serial output of the instrument proceed as follows:

1. Insert the SUB D female 9-pole connector of the adapter cable with electronics AD RS232C in the DIN 9-pole socket on the instrument.

2. Connect the SUB D female 25-pole connector of the fitting to the serial input of the printer or computer. The position of the switch in the connector must be:

**DCE:** data communication equipment (**Modem**)

**DTE:** data terminal equipment (**Computer**)

3. If you want to send what is shown on the display (once only), press the  $\Delta$  key until the instrument emits **two beeps**.

4. If you want to send what is shown on the display continuously, at a fixed rate of once every 10 seconds, press the  $\Delta$  key until the instrument emits **three beeps**.

5. To disable the serial output in continuous transmission, press the  $\Delta$  key until the instrument **does not emit a beep**.

6. If the serial output is not being used it is advisable not to fit the cable AD RS232C on the instrument, thus saving battery consumption.

### 7. Serial output: RS232C

Data transmission speed

300 baud

8 data bit length

1 start bit

1 stop bit

no parity

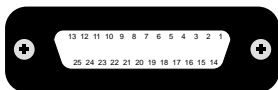
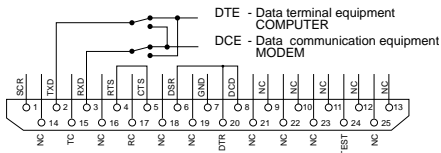
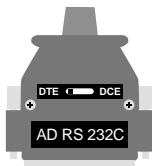

## ANALOG OUTPUT

It is possible to link up with the SUB D male 9-pole connector of the instrument to obtain an analog output:

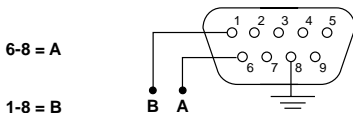

6-8 = A

1-8 = B

- A= 1,9 mV/°C
- 2,5 mV/lux
- 250 mV/W
- B= 1,9 mV/°C
- 2,5 mV/lux
- 250 mV/W

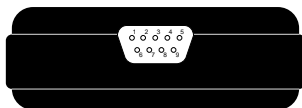

## BLOCK DIAGRAM

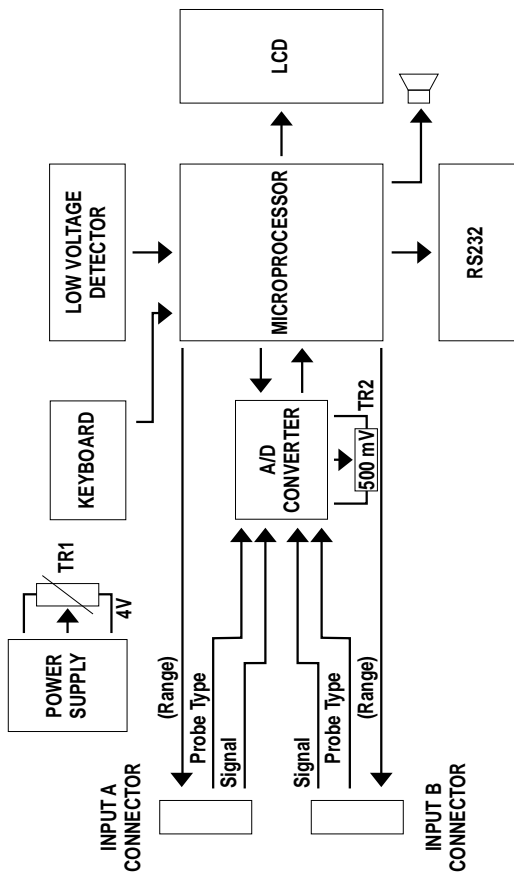

## LAYOUT OF COMPONENTS

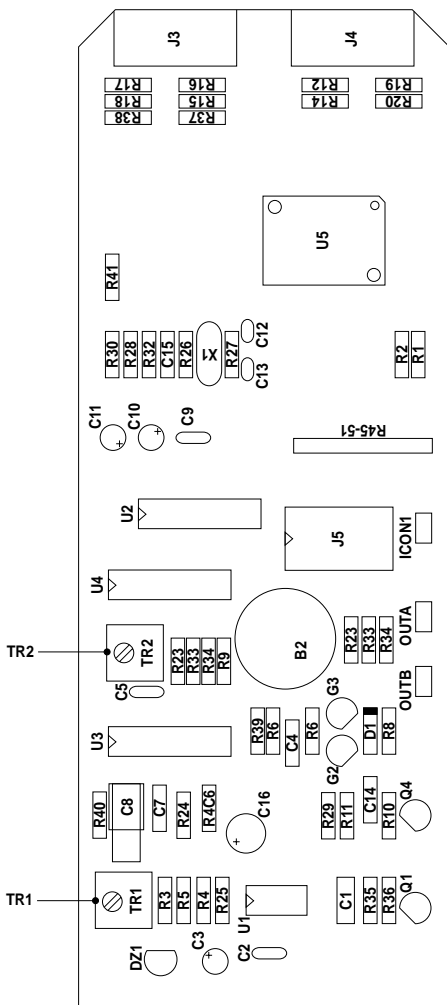

## CALIBRATING THE INSTRUMENT HD 9021

- 1) Open the instrument.
- 2) Connect the prods of a precision meter to the following pins on the input A (or B) connector: the positive to pin 7 (V+) and the negative to pin 6 (GND).
- 3) With the instrument and the meter switched on, turn the trimmer TR1 until the display on the meter indicates 4Vdc.
- 4) Insert the photometric simulator in the connector A (or B).
- 5) Turn the trimmer TR2 until the display on the instrument shows the same value as the simulator.

## SERIES HD 9021 PROBE CALIBRATION

- 1) Fit the probe in the instrument.
- 2) Fit the probe in the photometric bench.
- 3) Turn the trimmer T1 of the amplification and calibration circuit in the probe connector until the value shown on the display coincides with the value of the reference instrument.

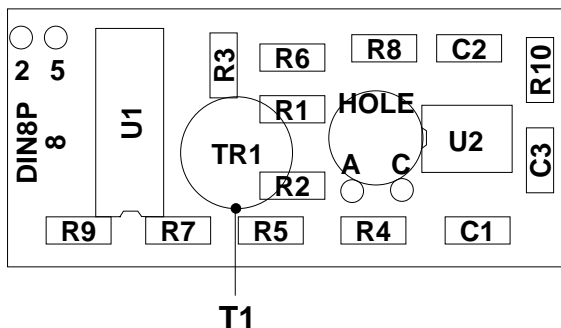

## GUARANTEE

This instrument is strictly inspected before being sold. However if there should be any defect due to manufacture and/or transport, apply to the dealer from whom you bought the instrument.

The guarantee period is 2 (two) years from the date of purchase. During this period all defects found by us will be repaired free of charge, **excluding those due to incorrect use and careless handling. The probes are not covered by the guarantee, as they can be irreparably damaged after only a few minutes of incorrect use.**

## CHARACTERISTICS

- Microprocessor-controlled multifunction quantum-photo-radiometric indicator with LCD indication for measuring sources of light and temperature. Measures ILLUMINANCE (lux, foot-candle), IRRADIANCE ( $W/m^2$ ) and RADIANCE ( $cd/m^2$ ).
- 2 inputs for probes and one for RS232C (with an optional adapter AD RS232C).
- Probe connection: 2 DIN 45236 8-pole sockets.
- Different silicon sensors for various types of measurement.
- Spectral response:
  - photometer 400÷760 nm photopic curve according to CIE (1924)
  - radiometer 190 nm - 3.5 micron
- Conversion frequency: 1 per second.
- Integration time: from 1 second to 1999 hours.

## TECHNICAL FEATURES

Measurements and measuring ranges:

- Photometer: Spectral range 400÷760 nm, automatic change of scale or 4 manual scales from 0 to 200,000 lx (0÷200,000 fcd). For measuring ILLUMINANCE.
- Radiometer: Spectral range 400÷900 nm, measurements from 1 microwatt/cm<sup>2</sup> to 200 mW/cm<sup>2</sup>. For measuring IRRADIANCE.
- UVA: Spectral range 315÷400 nm, peak at 365 nm, measurements from 10 nanowatt/cm<sup>2</sup> to 200 mW/cm<sup>2</sup>. For measuring IRRADIANCE.
- UVB: Spectral range 280÷315 nm, peak at 312 nm, measurements from 10 nanowatt/cm<sup>2</sup> to 200 mW/cm<sup>2</sup>. For measuring IRRADIANCE.
- UVC: Spectral range 190÷280 nm, peak at 250 nm, measurements from 10 nanowatt/cm<sup>2</sup> to 200 mW/cm<sup>2</sup>. For measuring IRRADIANCE.
- PAR (Photosynthetically active radiation): Spectral range from 400 to 700 nm, measurement in microEinstein per square metre per second, measuring range from 0 to 20,000  $\mu E m^{-2} \cdot s^{-1}$ .
- Luminance: Measuring range from 0 to  $1999 \times 10^3 cd/m^2$ .
- Instrument precision:  $\pm 0.1$  rdg  $\pm 1$  digit with a reference temperature of  $25^\circ C \pm 5^\circ C$ .
- Probe precision: Radiometric  $\pm 4\%$ .  
Photometric  $\pm 5\%$ .
- Linearity:  $\pm 1\%$ .
- Resolution:  $\leq 200 = 0.1$  ;  $\geq 200 = 1$ .
- Stability: 0.15%.
- Zero drift:  $\pm 0.05\%/^\circ C$  of reading.
- Working temperature: 0...50°C.
- Storage temperature: -20...+60°C.
- Relative humidity: 10÷85% RH.

- Display: LCD 12 mm, function and photo-radiometric symbols.
- Functions: Automatic and manual change of scale, integration time up to 1999 hours, auto power off. Storage and updating of the Maximum, Minimum and Q (Energy) values. Optoinsulated serial output RS232C with adapter AD RS232C. Analog output 1.9 mV/°C, 2.5 mV/lux, 250 mV/W.
- Power supply: 9V battery IEC 6LF22.
- Battery life: 150 hours with alkaline battery.
- Serial output: RS232C data transmission speed
 

300 baud	8 data bit length
1 start bit	1 stop bit
no parity	

**Use the optional adapter cable AD RS232C from SUB D female 9-pole to SUB D female 25 pole connectors.**  
Manual or automatic transmission of the value displayed; at a fixed rate of once every 10 seconds.

## **CHARACTERISTICS OF THE INSTRUMENT WHEN MEASURING TEMPERATURE WITH PROBES IN THE SERIES TP870**

Measuring range: -200°C...+800°C (-392°F...+1472°F) in two scales with automatic change of scale.

Resolution: -200°C...+200°C = 0.1, above that =1°C

Precision with TP870 probe included: -50°C...+200°C (-58°F...+392°F)  
±0.15% ±0.2°C ±1 digit  
over ±0.3% ± 1°C ±1 digit.

At temperatures higher than 400°C, avoid violent blows or thermal shock to the temperature probes as they may cause irreparable damage to the sensor.

Instrument container: ABS Bayer NOVODUR, black.

Weight of the instrument alone: 360 g

Weight of the kit: 2500 g

Dimensions of the instrument: 135x73x38 mm

Dimensions of the kit: 370x280x90 mm

## ORDER CODE

- HD 9021 K** : The kit is composed of the HD 9021 instrument, diplomatic carrying case, without probe.
- HD 9021 PHOT/C** : Photometric probe for measuring light, **illuminance**, photopic correction filter complying with CIE, diffuser for cosine correction. Range 0÷200,000 lux.
- HD 9021 RAD/C** : Radiometric probe for measuring light energy, **irradiance**, radiometric filter, diffuser for cosine correction. Range 400÷900 nm.
- HD 9021 RAD/PAR** : Radiometric probe for measuring radiations in the field of the PAR chlorophyll process (Photosynthetically Active Radiation 400÷700 nm), measurements in  $\mu$ Einstein, diffuser for cosine correction.
- HD 9021 RAD/UVA** : Radiometric probe for measuring radiation, **irradiance**, in the UVA wave length 315÷400 nm, peak at 365 nm. Quartz diffuser for cosine correction.
- HD 9021 RAD/UVB** : Radiometric probe for measuring radiation, **irradiance**, in the UVB wave length 280÷315 nm, peak at 312 nm. Quartz diffuser for cosine correction.
- HD 9021 RAD/UVC** : Radiometric probe for measuring radiation. **irradiance**, in the UVC wave length 190÷280 nm, peak at 250 nm. Quartz diffuser for cosine correction.
- HD 9021/Cd** : Photometric probe for measuring **luminance**, photopic correction filter complying with CIE. Measuring range from 0 to 200 cd/cm<sup>2</sup>.
- AD RS232C** : Connecting cable from SUB D female 9-pole to SUB D female 25 pole, complete with electronics, for serial output RS232C.
- TP 870** : Immersion temperature probe, Pt100 sensor, diam. 3x230 mm, range -60°C...+400°C.
- TP 870C** : Surface temperature probe, Pt100 sensor, diam. 4x230 mm, range -60°C...+400°C.
- TP 870P** : Penetration temperature probe, Pt100 sensor, diam. 4x150 mm, range -60°C...+400°C.
- TP 870A** : Air temperature probe, Pt100 sensor, diam. 4x230 mm, range -60°C...+300°C.

## PROBES

The primary purpose of the probes is to detect and measure light in its various aspects; for this reason there are different probes available to suit the different requirements. Probes are required for measuring **illuminance** (lux, foot-candle), **irradiance** ( $\text{W}/\text{m}^2$ ) and **luminance** ( $\text{cd}/\text{m}^2$ ). Each sensor has its own work band completed by filters or diffusors which correct or limit its range. The size of the silicon sensor used in the various probes is  $7.34 \text{ mm}^2$ . The probes are housed in a container of black anodized aluminium anticorrosion UNI 9006/4; the correction filters are made of special glass, while the diffusors are in quartz or plastic material specially designed for the purpose. The probe is complete with 2 metres of flexible cable and a DIN 45236 8-pole connector inside which is an electronic circuit that amplifies and codes the signal supplied by the sensor.

**The probes are calibrated individually and are therefore interchangeable.**

### HD 9021 PHOT/C

Photometric probe for measuring light, **ILLUMINANCE**, photopic correction filter complying with CIE, diffuser for cosine correction. Range  $0 \div 200,000$  lux ( $0 \div 200,000$  foot candle). This is the probe for measuring light with correction according to the human eye; it is suitable for measurements in offices, schools, laboratories, places of entertainment, emergency exits, car parks, galleries, shops, shop windows, factories, etc., in all lighting measurements.



The typical response curve of the probe is as follows:

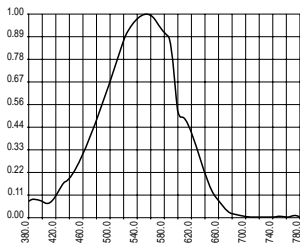

### HD 9021 RAD/C

Radiometric probe for measuring the **IRRADIANCE** of light sources, irradiance of the sun, etc. Radiometric filter and diffuser for angle correction according to the cosine law. Spectral measurement range 400÷900 nm, range from 1 microwatt/cm<sup>2</sup> to 200 milliwatt/cm<sup>2</sup>. The probe is used in greenhouses for measuring the power of artificial light, shade, the performance of solar panels, solar heating plants, solar filters, etc.



The typical response curve of the probe is as follows:

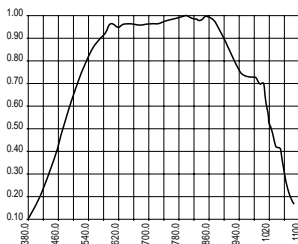

### HD 9021 RAD/PAR

Radiometric probe for measuring PAR radiations (Photosynthetically Active Radiation), works in the field of the chlorophyll process following a special response curve in a spectral range from 400 to 700 nm. The measurements are expressed in  $\mu\text{Einstein}$  in the range 0÷20,000  $\mu\text{E m}^{-2}\cdot\text{s}^{-1}$ .

**Photosynthetically Active Radiation, PAR.** Flow of photons in the wavelength 400÷700 nm.

**Photosynthetic photon flux density, PPRD.** The number of photons per time unit and air unit in the wavelength 400÷700 nm.

The measurement is expressed in micromoles per second and per square metre. One mole is the equivalent of  $6,0222\cdot 10^{23}$  photons.

Correction filter according to the cosine law.

Typical applications of the probe are for research in the field of greenhouse lighting, research in undergrowth, etc.



The typical response curve of the probe is as follows:

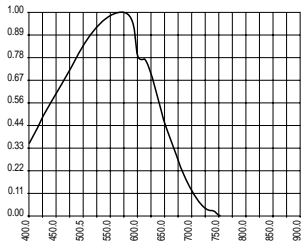

The study and field of application of ultraviolet rays has seen considerable growth in the last decades. The ultraviolet field is conventionally subdivided into the following three "bands":

- the band between the wavelengths from 400 to 315 nm. which includes radiations defined as type **A or UVA**;
- the band between the wavelengths from 315 to 280 nm. which includes radiations defined as type **B or UVB**;
- the band between the wavelengths from 280 to 100 nm. which includes radiations defined as type **C or UVC**.

The ultraviolet rays in natural light as it reaches earth through the atmosphere are of type **A**.

The amount of **UVA** in natural light is much greater than that emitted by traditional, incandescent bulbs, halogen or fluorescent lamps.

Save in the case of prolonged exposure, **UVA** rays possess a marked tanning action; they are not harmful to man but they may give rise to biological effects that may be beneficial for his health. The problem is the time of exposure; in fact, **UVA** rays have a considerable photochemical action that in the course of time produces phenomena of fading, cracking and decay.

Ultraviolet rays of type **B or UVB** have the property of encouraging the formation of vitamin D, but unless suitable precautions are taken they may cause erythema or conjunctivitis. The amount of **UVB** rays emitted by traditional lamps is very little in comparison with that emitted by sunlight and they are also much less than **UVA** rays.

**UVC** rays are useful thanks to their bactericide and ozonizing capacity, so they are used in the field of sterilization; another field of application that is being developed is in the polymerization of adhesives or resins (photoresist); as a drawback they cause more serious cases of erythema and conjunctivitis than **UVB** rays.

Depending on the effects that they produce, ultraviolet rays may also be classified as follows:

Producing ozone in the field	180÷220 nm
Producing bactericide (germicide) action in the field	220÷300 nm
Producing erythematous action in the field	280÷320 nm
Black light in the field	320÷400 nm

### HD 9021 UVA

Radiometric probe for measuring radiation power, **IRRADIANCE**, in the **UVA** wave length 315÷400 nm, peak at 365 nm. Quartz diffuser for cosine correction. Measuring range from 10 nanowatt/cm<sup>2</sup> to 200 milliwatt/cm<sup>2</sup>.



The typical response curve of the probe is as follows:

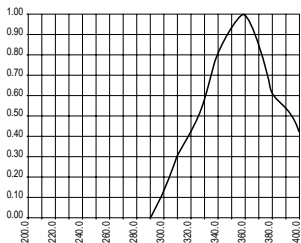

### HD 9021 UVB

Radiometric probe for measuring radiation power, **IRRADIANCE**, in the **UVB** wave length 280÷315 nm, peak at 312 nm. Quartz diffuser for cosine correction. Measuring range from 10 nanowatt/cm<sup>2</sup> to 200 milliwatt/cm<sup>2</sup>.



The typical response curve of the probe is as follows:

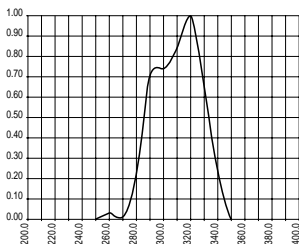

### HD 9021 UVC

Radiometric probe for measuring radiation power, **IRRADIANCE**, in the **UVC** wave length 190÷280 nm, peak at 250 nm. Quartz diffuser for cosine correction. Measuring range from 10 nanowatt/cm<sup>2</sup> to 200 milliwatt/cm<sup>2</sup>.



The typical response curve of the probe is as follows:

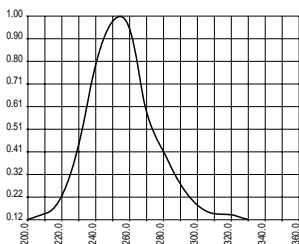

## HD 9021/Cd

Probe for measuring **LUMINANCE**, measuring range from 0 to  $1999 \times 10^3$  candles/cm<sup>2</sup>. Measuring angle 6° with opening surface 25 mm. CIE filter for correction according to the human eye.

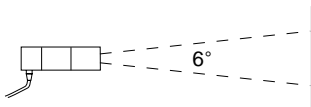

- The **CANDLE (cd)** is the light intensity in a specific direction of a source that emits monochrome radiation at a frequency of  $540 \times 10^{12}$  Hz and whose energetic intensity in that direction is 1/683 W/sr.
- The **STERADIAN (sr)** is the solid angle which, with its vertex in the centre of a sphere, subtends a spherical cap with an area equal to the square of the radius.
- **LUMINANCE** or **EMITTANCE** is the relationship between the light intensity emitted in a certain direction and the surface that emits it projected onto a plain perpendicular to the same direction; the measuring unit is the **cd/m<sup>2</sup>** (candle/square metre) or its submultiple **cd/cm<sup>2</sup>** (**1 cd/cm<sup>2</sup> = 10,000 cd/m<sup>2</sup>**).

Light flux	= lumen (lm)	= cd/sr
Illuminance	= lux (lx)	= lm/m <sup>2</sup>
Luminance	= nit (nit)	= cd/m <sup>2</sup>

CE CONFORMITY	
Safety	EN61000-4-2, EN61010-1 level 3
Electrostatic discharge	EN61000-4-2 level 3
Electric fast transients	EN61000-4-4 level 3
Voltage variations	EN61000-4-11
Electromagnetic interference susceptibility	IEC1000-4-3
Electromagnetic interference emission	EN55020 class B

#### GUARANTEE CONDITIONS

All our appliances have been subjected to strict tests and are guaranteed for 24 months from date of purchase. The Company undertakes to repair or replace free of charge any parts which it considers to be inefficient within the guarantee period. Complete replacement of the instrument is excluded and no requests for damages are recognized, whatever their origin. Repairs are carried out in our own Technical Service Department. Transport expenses are borne by the buyer. **The guarantee does not include: accidental breakages due to transport, incorrect use or neglect, incorrect connection to voltage different from that contemplated for the instrument, probes, sensors, electrodes and all accessories.** Furthermore the guarantee is not valid if the instrument has been repaired or tampered with by unauthorized third parties, or adjusted for faults or casual checking. The guarantee is valid only if all parts of the guarantee card have been filled in. Any instruments sent for repairs must be accompanied by their guarantee certificate. For all disputes the competent court is the Court of Padua.



DELTA OHM SRL  
VIA G. MARCONI, 5 - 35030 CASELLE DI SELVAZZANO (PD) - ITALY  
TEL. 0039-0498977150 r.a. - FAX 0039-049635596  
e-mail: [deltaohm@tin.it](mailto:deltaohm@tin.it) - Web Site: [www.deltaohm.com](http://www.deltaohm.com)